



Rely on it.

Creativity at a dream price

RENOLIT ALKORPLAN Design



RENOLIT
ALKORPLAN
roofing products



The only 5-in-1 solution for aesthetic roofs

RENOLIT ALKORPLAN Design

The perfect answer on any visible roof for architects, roofing contractors and clients.

Metal roofs are currently experiencing a renaissance. Not just on public and industrial buildings but moreover on private residential construction. No wonder since there is something special about a metal roof. It exudes quality, style and above all durability. Think of listed buildings with weathered copper roofs. But traditional copper, zinc or aluminium roofs clearly have a number of disadvantages too. Installation of metal standing seam is labour-intensive and requires sound expertise in order to achieve a correct result. Often there can be problems in terms of building physics, leading to condensation, moisture problems and poor heat and sound insulation properties. Not to mention a sizeable price tag.

RENOLIT provides a great alternative to standing seam metal roofs, a solution that is both striking and easy to install: **RENOLIT ALKORPLAN Design!** A lightweight and above all flexible system, which may be used for any roof shape without inherent connection or condensation issues. The variety of trendy metallic colours is a major asset. In addition this roof system can generate savings as high as 40% over a metal alternative.

With over **45 years of experience** in synthetic waterproofing membranes, **RENOLIT** is a reliable partner and the reason why the **RENOLIT ALKORPLAN Design** system has been installed by roofing contractors worldwide for decades. Both for new construction and refurbishment projects..

Discover 5 convincing reasons for choosing **RENOLIT ALKORPLAN Design**.

- 1

Unbridled creativity.

A flexible and ultra-light synthetic solution that can be used on any roof shape..

p7
- 2

Affordable class.

An aesthetic roof with the allure of zinc, copper or aluminium at a dream price..

p9
- 3

Colourful design.

Dare to be bold and give your roof unique character.

p11
- 4

Quick and easy to install.

Simple installation of roofing membrane and profiles using hot-air welding.

p13
- 5

Reliable waterproofing.

Soundproof, vapour-permeable and no thermal expansion.

p15

System design

RENOLIT ALKORPLAN Design

A synthetic roofing membrane and an extruded profile... nothing else is required for a watertight roof with the looks of metal standing seam. More importantly, with the **RENOLIT ALKORPLAN Design** system, you opt for an ideal combination: the reliability of **RENOLIT ALKORPLAN For** A roofing membranes paired with the attractive appearance of a metal roof thanks to **RENOLIT ALKORPLAN Design** profiles.

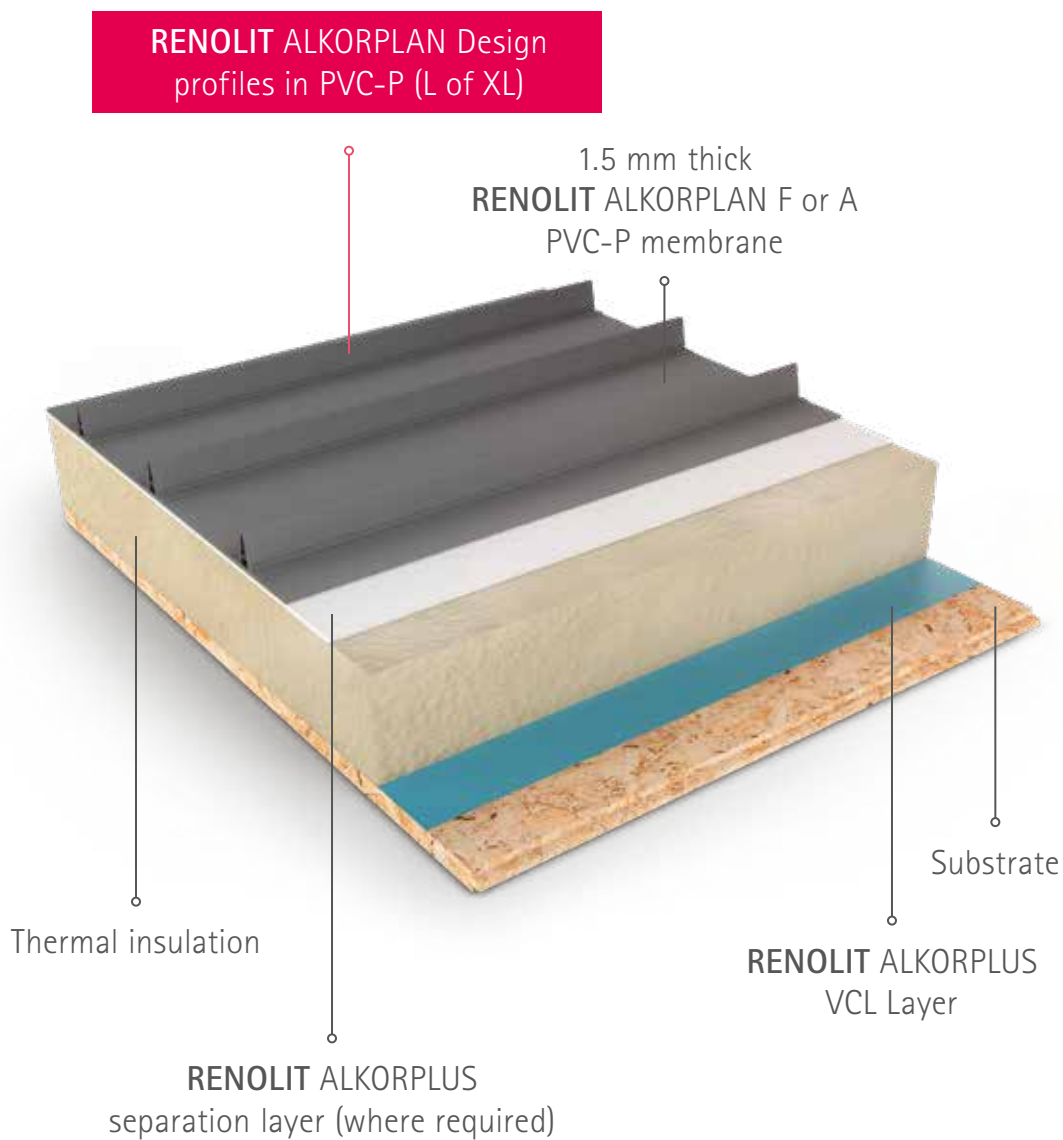

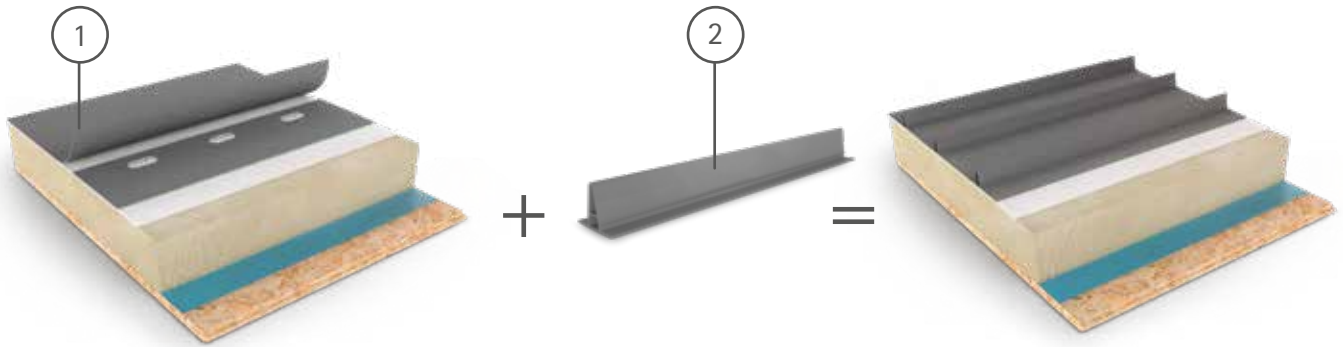

Perfect looks, reliability and longevity

The 1.5 mm thick PVC-P **RENOLIT ALKORPLAN F** roofing membrane with polyester reinforcement and **RENOLIT ALKORPLAN A** fleece-back membrane represent experience and quality. The extruded PVC-P profiles hot-air welded on top add the finishing touch. A purely aesthetic finish which is not detrimental to the waterproofing! For an installer, this finish will come as a breath of fresh air compared with the complexity of a metal roof with actual standing seams. This combined with a life expectancy assessed by the British Board of Agrément (BBA) up to 40 years.

RENOLIT ALKORPLAN Design profiles.

There are a choice of profiles available: the more discrete L profile or the slightly more striking XL. It should be noted that the extruded profiles are also manufactured by **RENOLIT** in-house! Our guarantee of quality.

Fireproof: the **RENOLIT ALKORPLAN** Design system has a fire resistance $B_{roof}(t4)$ in accordance with EN 13501-5, CE approval and continuous technical certification.

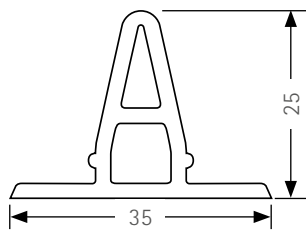

RENOLIT ALKORPLAN Design L profile Large

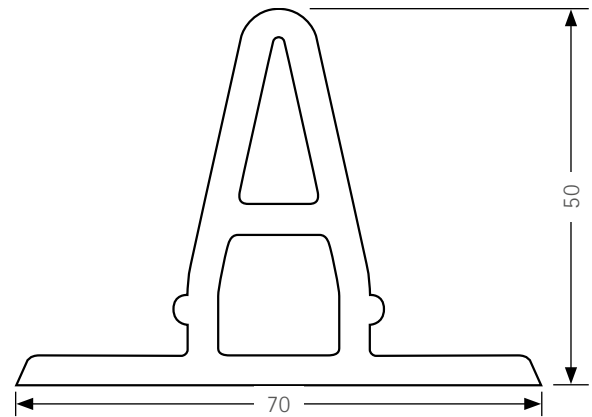

RENOLIT ALKORPLAN Design XL profile X-Large

Sections of the RENOLIT ALKORPLAN Design system:

1. RENOLIT ALKORPLAN F and A roofing membrane		+	2. RENOLIT ALKORPLAN Design profiles		RENOLIT ALKORPLAN Metallics	
	F	A		LARGE	X-LARGE	LARGE
Thickness	1.5 mm	1.5 mm	Size	35 x 25 mm	70 x 50 mm	35 x 25 mm
Width	1.05 m	2.10 m	Container	40 units	20 units	40 units
Length	20 m	15 m	Length	3 m	3 m	3 m
Colours			Colours			





Unbridled creativity

RENOLIT ALKORPLAN Design

The roof influences the look of the building and can even enhance the architecture. This is where an architect may be creative. Architects like to move boundaries, be it for a new building or a refurbishment.

However, they are often confined on technical aspects. Too low a pitch, overly complex roof shape, or it is impossible to implement a watertight finish. All situations where traditional roofing materials fall short.



Carte blanche

With the **RENOLIT ALKORPLAN Design** system the architect has carte blanche. Thanks to the flexibility of PVC-P roofing membrane and profiles, it is possible to work with challenging forms without limitation. In addition this is enhanced by a warm roof structure incorporated in the system.

There are lots of creative possibilities, from complex curved or sinusoidal roof shapes, to flat, sloping or even vertical variants... Furthermore, the roof can be finished using the same material, even as a continuation of, or an extension to, the façade. An ideal solution for a sleek design.

RENOLIT ALKORPLAN Design has been specially developed with aesthetics and visible roofs in mind. A creative opportunity for any architect.

Extra service: Contact our technical staff if you have any questions about a **RENOLIT ALKORPLAN Design** application. We will be happy to share our wealth of experience and offer creative solutions.

TIP Also use the online specifications service at www.renolit.com/roofing. This handy, simple and free tool provides you with a ready document in a matter of clicks.



Office building - Belgium
Sleek perfectly fitting connections - something that is not feasible with metal on account of the required ventilation space - are not a problem thanks to **RENOLIT ALKORPLAN Design**.



Affordable class

RENOLIT ALKORPLAN Design

Many people gaze in admiration at the beauty of an aluminium, zinc or copper roof. But the reality usually scares them off... the price tag! Not surprising since the price of such metals is rapidly increasing, year upon year. The installation with standing seams also takes time and we know that labour charges are reflected heavily in the cost price.

No large investment

Yet a roof similar in appearance to aluminium, zinc or copper does not necessarily have to be a costly investment.

RENOLIT offers an excellent and durable alternative, with its **RENOLIT ALKORPLAN Design** system. A synthetic aesthetic roof with the allure of metal standing seam at a very affordable price. The lower material cost compared with metal is, of course, a decisive factor. But a favourable installation time also plays a part:

- no time-consuming standing seam finish
- no fixing clips and distributor plates
- roof details simple to execute
- quick and easy installation thanks to hot-air welding technology
- warm roof structure

For complex roof shapes, the **RENOLIT ALKORPLAN Design** system can deliver savings of up to 40 %. This really matters to an owner or project developer. And there's another significant plus point. The **RENOLIT ALKORPLAN** roofing membrane weighs just 1.8 kg/m². An attractive feature because this means it is also possible to save on the loadbearing structure too..



Seaside Health and Rehabilitation centre – Netherlands



Lead grey
73321

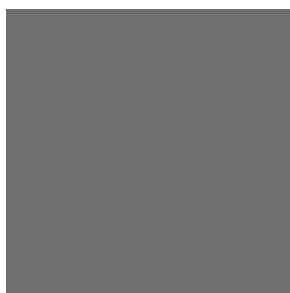

Charcoal
79851

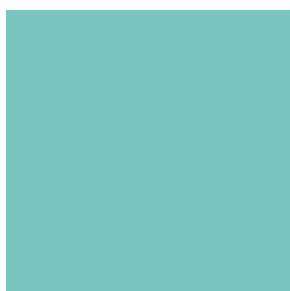

Copper green
60884

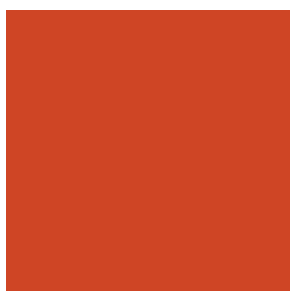

Terracotta
82119

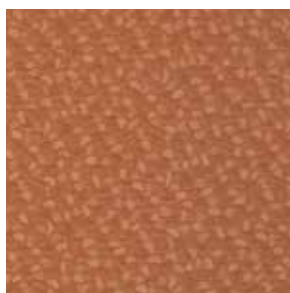

Copper
84040

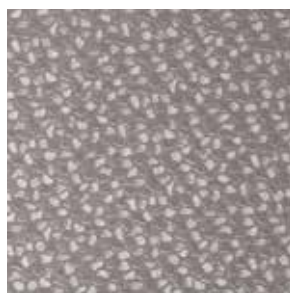

Silver
40100



Colourful design

RENOLIT ALKORPLAN Design

Colour increasingly plays a role in contemporary architecture. That also applies to roofs. For example, in modern architecture the roof often forms one single unit with the façade. Besides, there are also new trends. The old-style industrial look is in vogue on private residences and large-scale prestigious projects. Metal and as a consequence metal colours are firm favourites.

The important role of colour

RENOLIT echoes this trend and offers as standard within the RENOLIT ALKORPLAN Design range six trendy colours for visible roofs. With the green of patinated copper, the grey of elegant zinc, striking terracotta or a refined anthracite, a roof may obtain a unique personality that goes well with the design of a building. Together with the RENOLIT ALKORPLAN Design profiles in L or XL, your roof also gains that typical standing seam look of a metal roof.

RENOLIT ALKORPLAN Metallics

If you want something even more eye-catching, you can choose a roof in shiny aluminium or trendy industrial copper, two striking colours with a special metallic surface. The corresponding profiles are available in L-format and have an even surface. If this colour range is not what you're after, we will look for another solution that is tailored to you. A custom-made colour is negotiable provided that certain conditions are met.

Our coloured roofing membranes comply with the $B_{roof}(t4)$ standard for pitched roofs. Contact RENOLIT for the terms and conditions.

Note: the geographic location of a building can be decisive for determining which colour may or may not be used.

TIP Combine the chosen colour for the roof surface with profiles in a different colour and create your own original style.



Architects' house - Belgium
Terracotta roof surface combined with façade in Corten steel



Quick and easy to install

RENOLIT ALKORPLAN Design

As a roofing contractor you will no doubt be aware that a metal roof is not the easiest to install. This is something an architect is aware of too because experienced craftsmen for metal roofs are scarce. Owing to the complexity, the aesthetics, the durability and prevention of water ingress can be seriously compromised.

*In comparison, the **RENOLIT ALKORPLAN Design** system is a dream material for a roof installer. Even for the most complex challenges! Unlike metal roofs, installation itself is rather more straightforward and a less labour-intensive process. No time consuming fixing clips and distributor plates, and in particular no delicate standing seam finish with the guarantee of being watertight.*

Simple waterproofing

In the first instance, the roof is made waterproof with **RENOLIT ALKORPLAN** single ply roofing membrane, a product that is quick and easy to install and equally important, lightweight. The membrane is jointed with an overlap and sealed by means of hot air welding. Roof detailing is simple and fast.

RENOLIT has a wide range of matching roof accessories for this purpose (preformed angles, metal sheet, ...).

The impression of standing seam

The finish with standing seam is only applied once the roof has been fully sealed. **RENOLIT ALKORPLAN Design** profiles are positioned on the roof surface above the overlap. Spot welding every 5 to 10 cm facilitates the work and helps to prevent the profiles from moving. The two sides of the profile are then welded into place. The edges may be finished optionally afterwards with **RENOLIT ALKORPLAN PVC** seam sealer. Depending on the desired design, extra profiles may be added between overlaps or at specified centres.

Important! Always weld the profiles parallel to the roof incline for drainage purposes.

TIP for the installer! **RENOLIT** regularly organises **RENOLIT ALKORPLAN Design** training courses. Sign up now via our website and become an "approved **RENOLIT ALKORPLAN Design**" installer yourself.

Maintenance

RENOLIT ALKORPLAN Design roofs require little in the way of maintenance. An annual inspection together with cleaning of the gutters and water outlets...nothing else!

Recycling

After its service life, the old **RENOLIT PVC-P** membrane is also fully recyclable into new raw material. **RENOLIT** as a company is fully committed to sustainability through VinylPlus and ROOFCOLLECT.





Reliable waterproofing

RENOLIT ALKORPLAN Design

Traditional metal roofs present a number of difficulties with regard to building physics. The consequences are not always good.

Metal roof versus RENOLIT ALKORPLAN Design

Excessive noise levels may be one such consequence of a metal roof. Hail and rain or expansion joint movement can lead to annoying noise. For this reason, the space beneath a traditional metal roof is not always habitable or insulation must be installed between the rafters which may lead to additional problems.

- In the case of a **RENOLIT ALKORPLAN Design** system, a warm roof solution is provided which means there is **little to no nuisance noise**. All spaces, even those directly below the roof, can therefore be used without any problem.

Another downside of metal standing seam on the roof is the risk of condensation. It is inherently vapour tight. Since provision has to be made for a ventilation opening beneath the metal, it remains difficult to keep these roofs free of condensation. Humidity, water droplets and moisture...does this leave you with an uneasy feeling?

- The **RENOLIT ALKORPLAN Design** system is not affected by this problem. **RENOLIT ALKORPLAN** roofing membrane is not only waterproof but in addition also **vapour permeable**. This means that the roof can continue to breathe. The risk of ventilation problems - and so condensation problems are virtually non-existent.

With metal roofs there are also expansion problems. Metal is subject to thermal expansion and so movement joints must be provided between the sections. The more expansion joints, the greater the chance of water leaks. For a complex roof shape, an expansion joint is also very difficult to execute correctly.

- The great benefit of a PCV roofing membrane is its **flexibility**. **RENOLIT ALKORPLAN** is not affected by changes in the ambient temperature. The roofing membrane can be installed continuously and to the desired length. No additional labour, no increased risk of leaks.

RENOLIT ALKORPLAN Design, your guarantee of stylish looks combined with reliable waterproofing and therefore years of appeal and service!





Terracotta on a private residence - Netherlands



Copper green on a chapel - Netherlands



Copper on Tops Arena - Netherlands

Some examples of our work

RENOLIT ALKORPLAN Design



Lead grey on House of Tomorrow Today - Netherlands





Charcoal on tower – Belgium



Light grey on private residence – Belgium



Copper green on golf club – Netherlands



Lead grey on The Friends Day Care Centre - United Kingdom



Charcoal on dog care centre - United Kingdom



Metallic copper on Rosemount Clinic - United Kingdom



The British Board of Agrément have assessed the life expectancy of RENOLIT ALKORPLAN F used in the United Kingdom to be in excess of 40 year with extended maintenance.

RENOLIT ALKORPLAN roofing products and system have a standard guarantee of 10 years, and are installed by approved contractors and installers who are trained and assessed by RENOLIT.

All RENOLIT waterproofing membranes for roofing are part of the ROOFCOLLECT® collection and recycling programme.

The RENOLIT Iberica S.A. factory in Barcelona is approved to ISO 9001/14001.

www.renolit.alkorplan.com

RENOLIT UK Ltd, Station Road - Cramlington, Northumberland NE23 8AQ - United Kingdom

T +44 1670 718283 - F +44 1670 590096 - renolit.cramlington@renolit.com

RENOLIT Belgium N.V. - Export Dpt. - Industriepark De Bruwaan 3 - 9700 Oudenaarde - Belgium

T +32 (0)55 33 98 51 - renolit.belgium@renolit.com

The information contained in the present commercial literature has been given in good faith and with the intention of providing information. It is based on current knowledge at the time of issue, and may be subject to change without notice. Nothing contained herein may induce the application of our products without observing existing patents, certificates, legal regulations, national or local rules, technical approvals or technical specifications or the rules and practices of good workmanship for this profession. The purchaser should verify whether import, advertising, packaging, labelling, composition, possession, ownership and the use of our products or the commercialisation of them are subject to specific territorial rules. He is also the sole person responsible for informing and advising the final end user. When faced with specific cases or application details not dealt with in the present guidelines, it is important to contact our technical services, who will give advice, based on the information at hand and within the limitations of their field of expertise. Our technical services cannot be held responsible for the conception of, nor the execution of the works. In the case of negligence of rules, regulations and duties on the part of the purchaser we will disclaim all responsibility. The colours respect the UV resistance required by EOTA, but are still subject to the natural change over time. Are excluded from the guarantee: aesthetic considerations in case of partial repair of deficient membrane covered by the guarantee. The product availability differs from country to country, please refer to the RENOLIT technical department for further advice.



Rely on it.